



MyTobii Augensteuerung



Eyetracking

- Die Augen verraten, was man denkt und fühlt
- Eyetracking wird seit den 1970er Jahren als Analyseinstrument eingesetzt
- 2001: Gründung von SMI in Schweden mit dem Ziel, die User Experience zu verbessern



Anwendungen des Eyetracking

- Passive eye interaction
- Active eye interaction



Passive eye interaction

- Marktforschung
- Usability
- Wissenschaftliche Anwendungen
- Industrielle Anwendungen
- Militärische Anwendungen
- Medizin

mytobii
P10

Active eye interaction

- Industrielle und militärische Anwendungen
- Gaming
- Medizin
- Assistive Technology
 - Cerebralparese
 - ALS
 - MS
 - Hoher Querschnitt

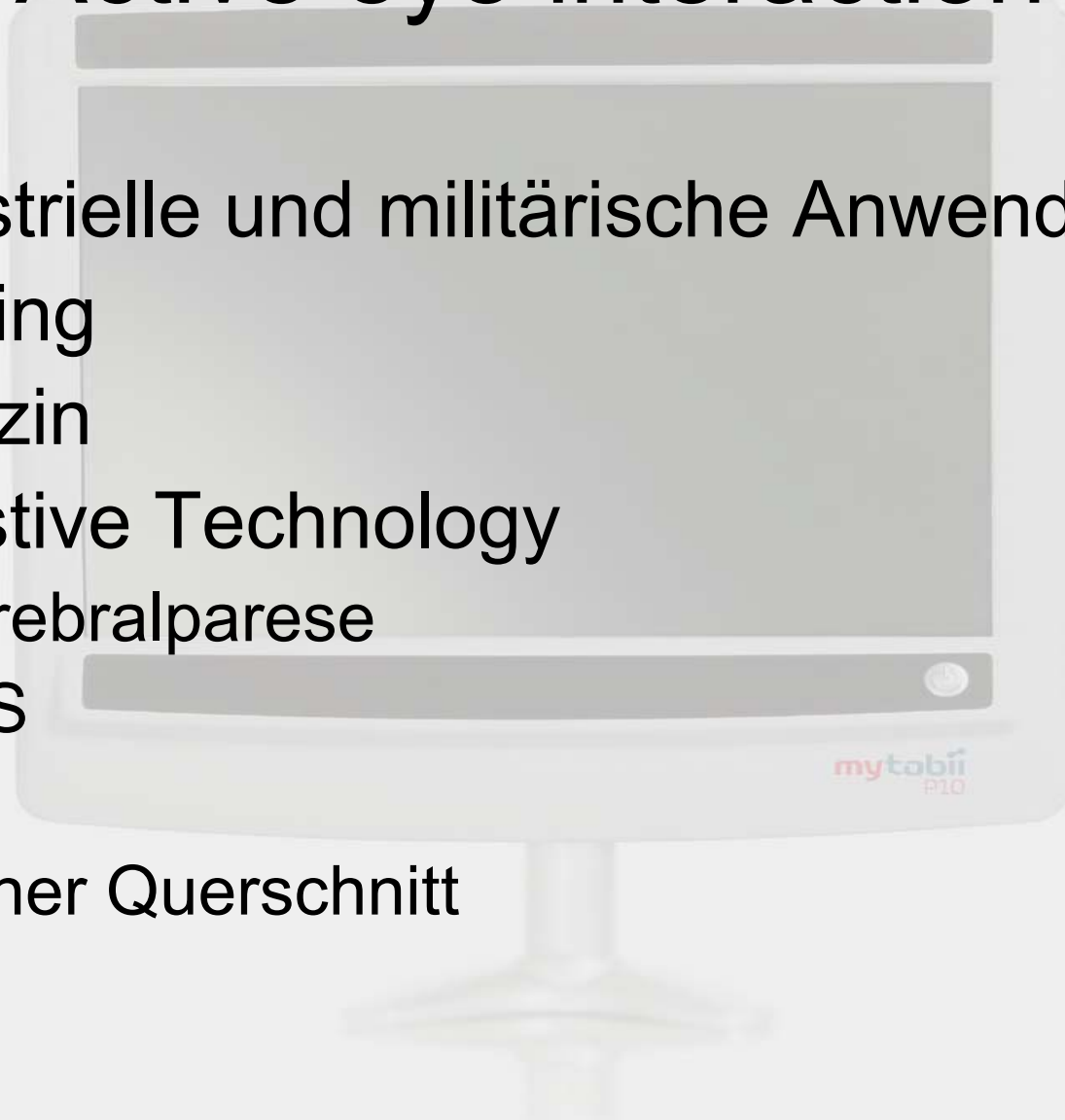



mytabii
P10

MyTobii Augensteuerung

- Moderne Messsysteme können den Punkt der Aufmerksamkeit aus einer Entfernung von 60 cm noch auf 0,5-1cm genau bestimmen.

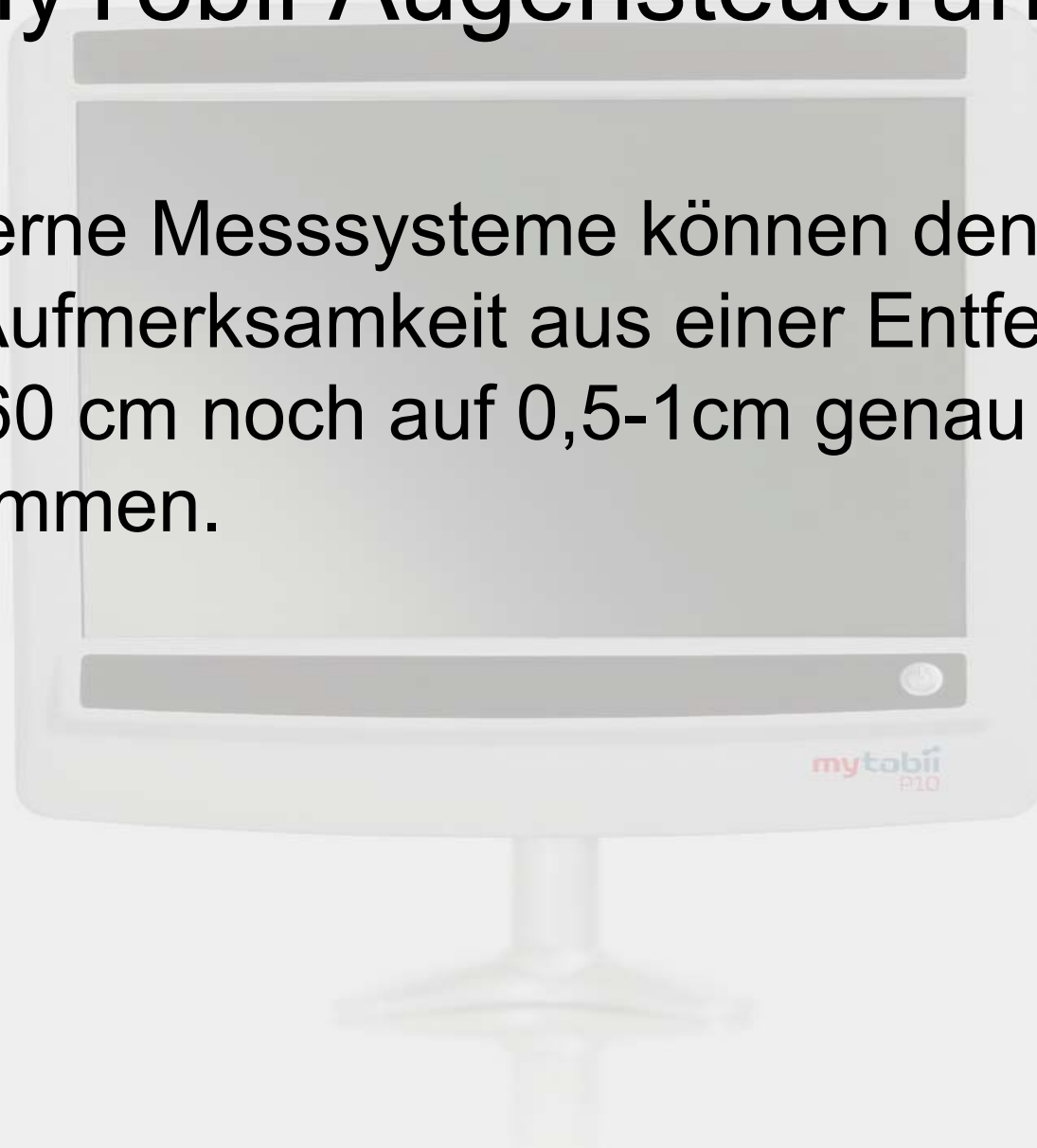

MyTobii Augensteuerung

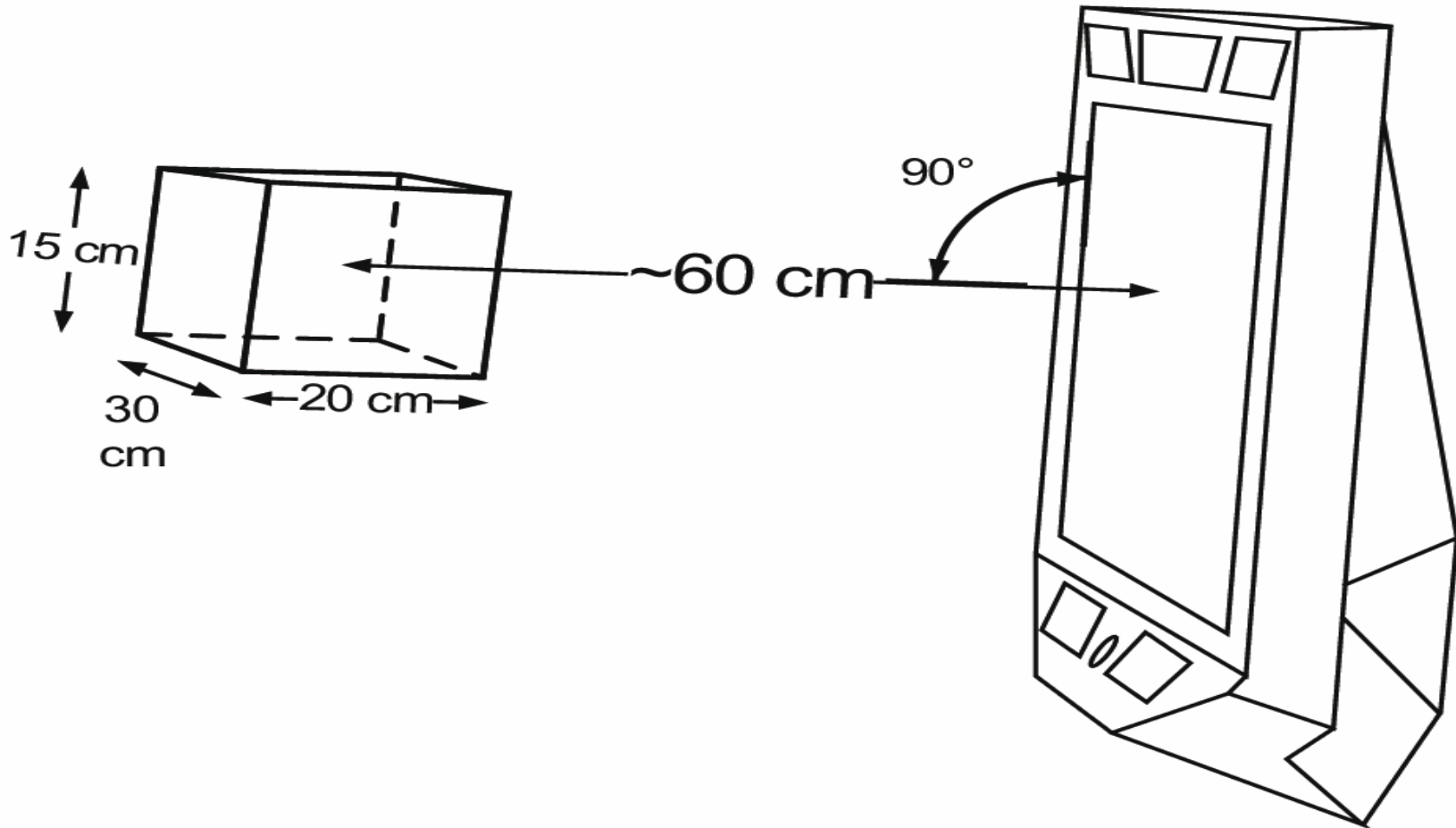

1. Schritt: Trackstatus

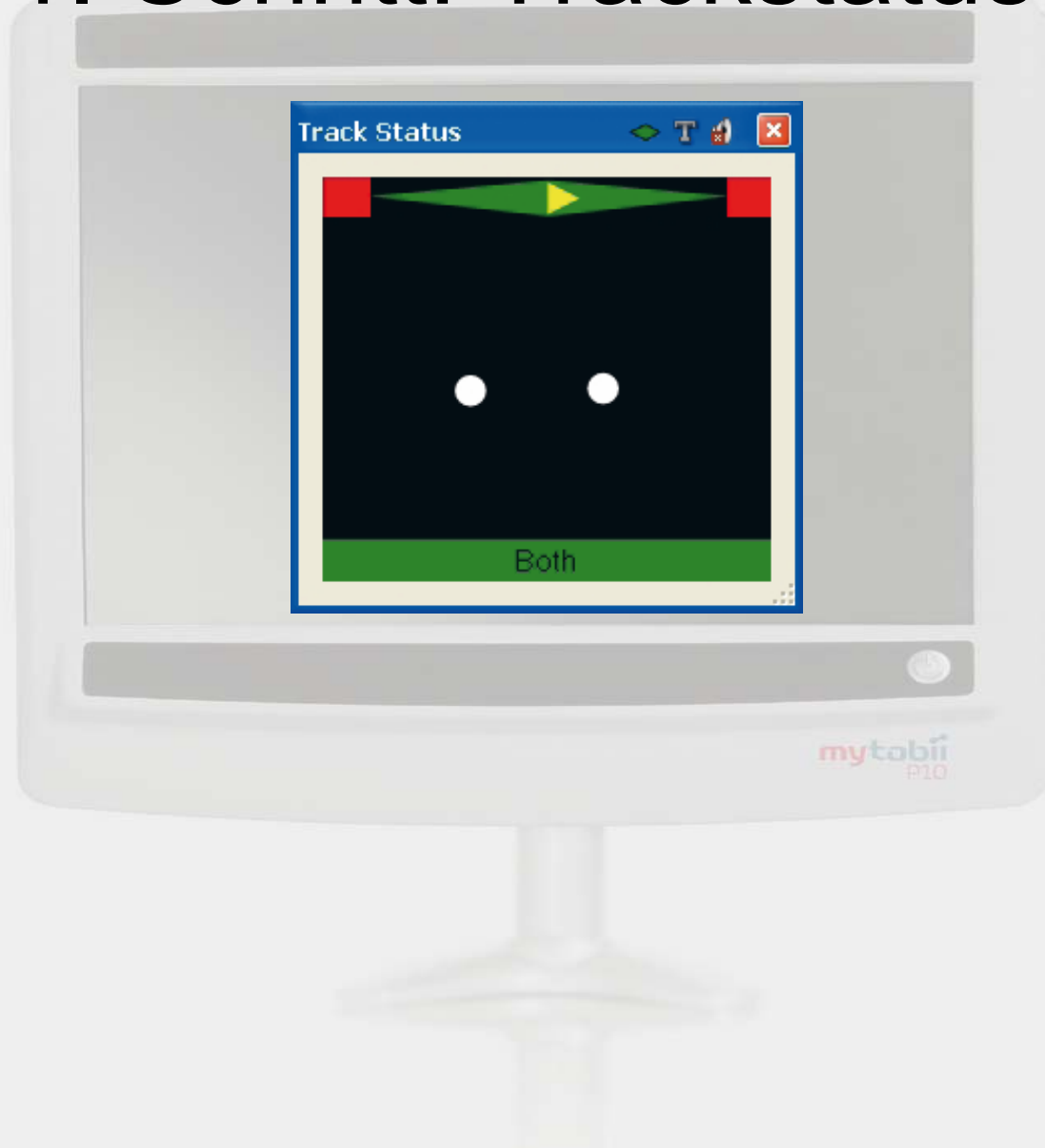

2. Schritt: Kalibrierung

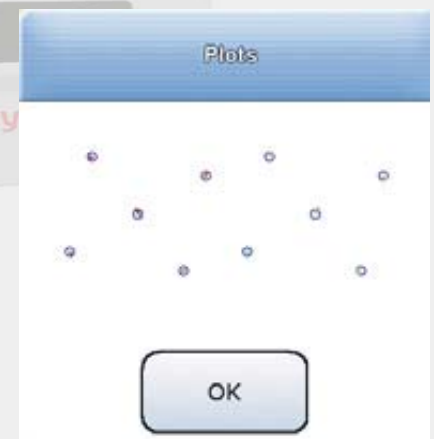
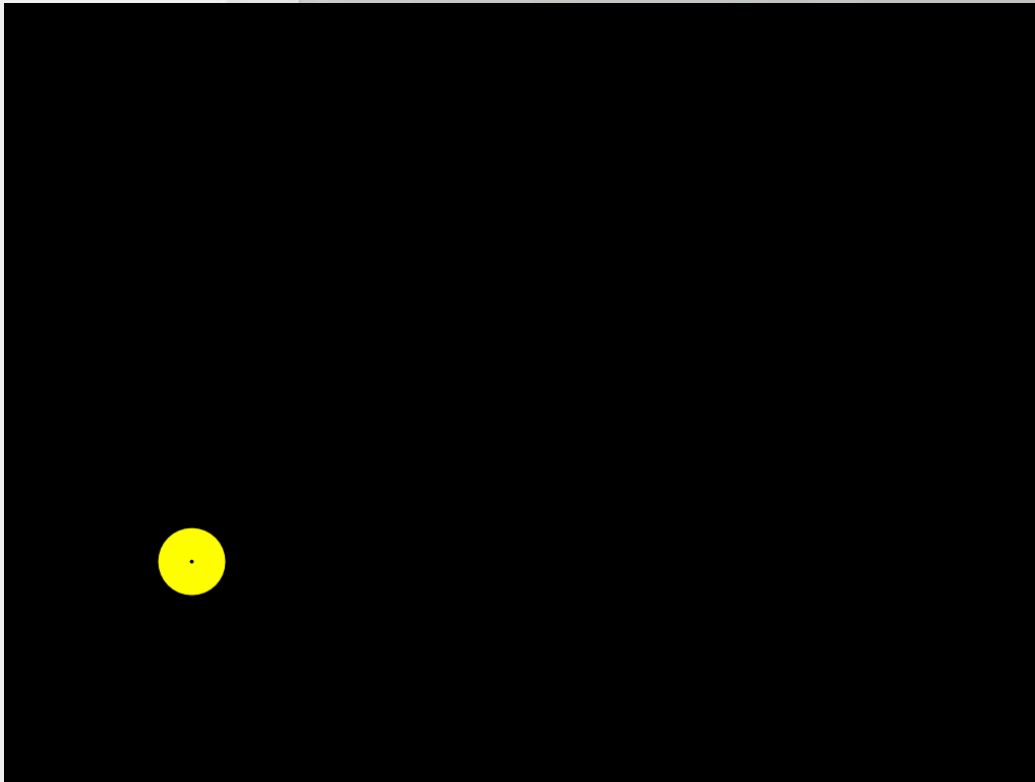

Grundeinstellungen



Dwellmodus



Kalibrieren



Erweiterte
Einstellungen



Taste
verwenden



Track status



Application
Manager



Lidschlag
verwenden



Profil
auswählen



Gaze
Evaluator



Zurück



MyTobii
beenden

Desktop



Webbrowser



Windows Steuerung



Mail



Media Player



Dokument-Auswahl



Text-Editor



Spiele



Programme

Bildschirmtastatur

Text Einfg.

So kann ich mit den Augen schreiben

Werkzeuge

1

2

3

4

5

6

7

8

9

0

q

w

e

r

t

z

u

i

o

p

a

s

d

f

g

h

j

k

l

ü

ß

y

x

c

v

b

n

m

ö

ä

123..

ABC

Space

Del

Nav



Mail erstellen



An

Irmgard.steininger@lifetool.at



Betreff

MyTobii



Text

Liebe Irmil!

Es geht |



Anhänge



Senden



Zurück



Google

Web [Bilder](#) [Maps](#) [News](#) [Shopping](#) [Google Mail](#) [Mehr](#) ▾

[iGoogle](#) | [Anmelden](#)



[Erweiterte Suche](#)
[Einstellungen](#)
[Sprachtools](#)

Suche: Das Web Seiten auf Deutsch Seiten aus Deutschland

[Werben mit Google](#) - [Unternehmensangebote](#) - [Über Google](#) - [Google.com in English](#)

©2008 - [Datenschutz](#)

My Tobii Werkzeuge

Maus-Menü

System-Menü

Media Player

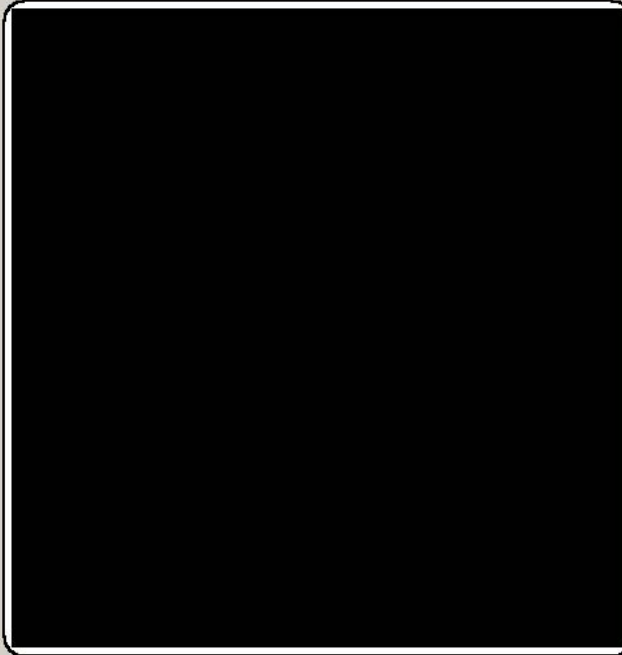

Keine Objekte im
Medienverzeichnis



<>
Volume: 50/100
Mode: Normal



Back



MyTobii Werkzeuge

Maus-Menü

System-Menü

Hilferuf

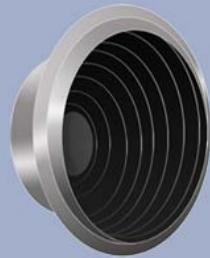

My Tobii Werkzeuge

Maus-Menü

System-Menü



Start

Offer draw

Start demo

Options

Exit

System-Menü

Desktop



Hoch



Hilferuf

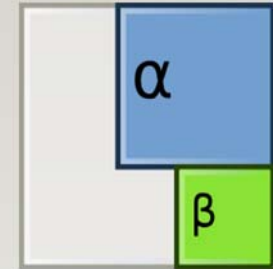



Dasher



VS Communicator 4

System-Menü

 Pause	 Ein- stellungen
---	---

MyTobii Werkzeuge

Maus-Menü

System-Menü

Viking Communicator

- Vorgefertigte Tastaturen und Symboltafeln
- Hochqualitative synthetische Stimmen
- Email
- SMS
- Chat
- Telefonieren
- Umfeldsteuerung



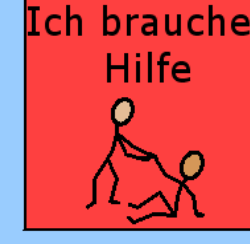
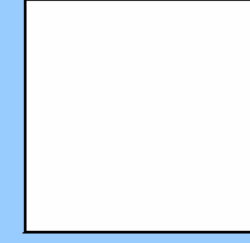
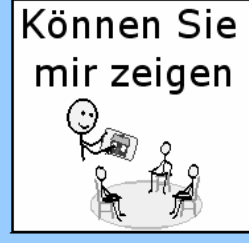
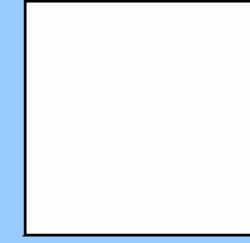
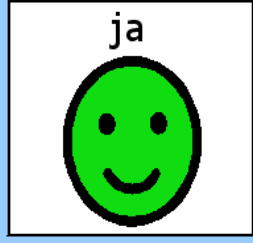
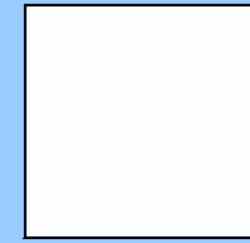
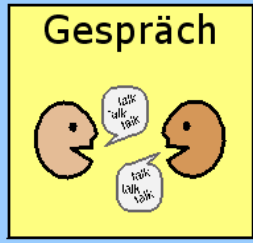

Diese Spezialtastatur mischt Buchstaben, Wortvorhersage und häufige Wörter, um die Schreibgeschwindigkeit zu erhö

Alles löschen
Wort löschen
Text ausgeben

erhöht Erhöhung erhöhen erhöhte
erhöhten

I	mir	mein	Papa	q	w	e	r	t	z	u	i	o	p	ü
Du	Du	ihr	Mama	a	s	d	f	g	h	j	k	l	ö	ä
er	ihm	sein	Jenny	y	x	c	v	b	n	m	,	.	-	ß

sie	sie	sie	John				Zurück zu W		Abc	ABC	!/?#	123
-----	-----	-----	------	--	--	--	-------------	--	-----	-----	------	-----

es	es	sein/ihr	wollen	brauch-en	wie	liebe	bin	Hallo	auf wiedersehen	tun	ja
----	----	----------	--------	-----------	-----	-------	-----	-------	-----------------	-----	----

wir	wir	unser	essen	trinken	lesen	spielen	gehen	bitte	Danke	Entschuldigung	nein
sie	ihnen	ihre	ist/sind	Tun Sie es nicht	a	ein	die	mehr	an	in draussen	Tun Sie es nicht

Gehe zu Seite 2

Ausgang

Umfeldsteuerung

